

LTQ XL™
Linear Ion Trap
Mass Spectrometer

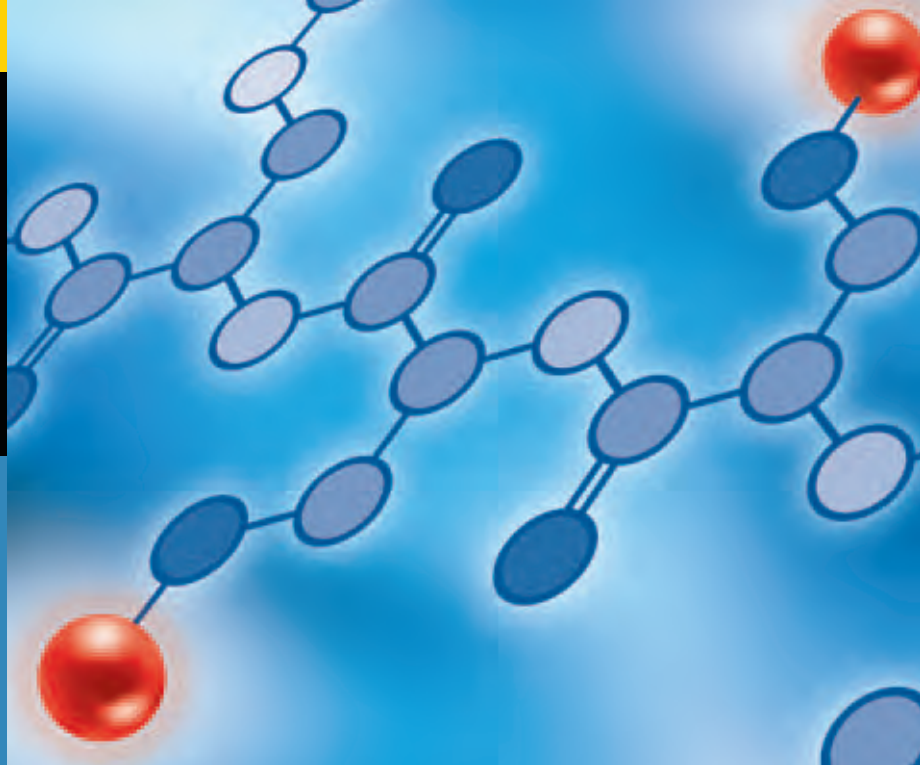

More Structural Information with MSⁿ

SUPERIOR ION TRAP TECHNOLOGY

From the leader in Ion Trap Mass Spectrometry, the LTQ XL Linear Ion Trap delivers ultimate sensitivity at breakthrough speed.

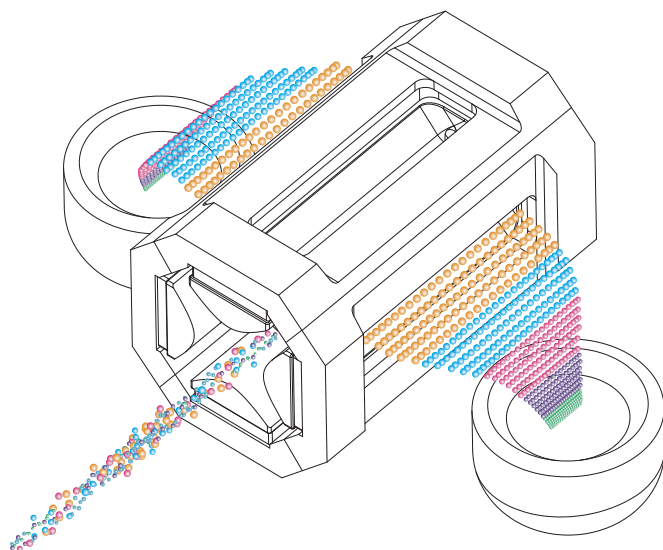

Proteomics:

- **Maximum protein coverage resulting from superior cycle times and sensitivity**
- **Automated MSⁿ triggered Data Dependent™ neutral loss scan**
- **Flexibility of ionization modes, inlets, and chromatographic solutions**

Metabolite Identification:

- **Superior MSⁿ spectral quality and full-scan acquisition**
- **Structural information on low level metabolites without knowing MRM transitions**
- **Data Dependent and Dynamic Exclusion™ acquisition for maximum information in complex samples**

Discovery Quantitation:

- **Excellent ion statistics for robust quantitation**
- **Optimum efficiency with Normalized Collision Energy™**
- **Simultaneous identification and quantitation for the regulated laboratory environment**

Forensic and Clinical Analysis:

- **Outstanding robustness for reliable quantitation in complex matrices**
- **Simultaneous quantitation and confirmation in both positive and negative ionization modes**
- **Ease of use for the production laboratory**



With the Accela™ High Speed LC System, the LTQ XL is the perfect tool for high throughput applications.



Using multiple dissolution techniques, including Pulsed-Q Dissociation (PQD) and Electron Transfer Dissociation (ETD), the LTQ XL generates extensive structural information for the most demanding proteomics samples.

The LTQ XL Linear Ion Trap—
Technology You Can Trust

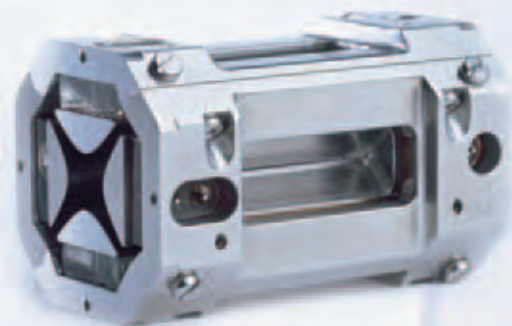

METABOLITE IDENTIFICATION AND CONFIRMATION

Automatically find all the metabolites the first time, even the ones that you didn't predict...

Metabolic studies are performed both *in vivo* and *in vitro* necessitating the analysis of target compounds in complex matrices. These biological matrices contain the parent drug, all of its metabolites in a wide range of concentrations, and additional endogenous metabolic materials. Furthermore, it is not possible to predict, in advance, all of the metabolites for a potentially new drug compound.

Intelligent precursor ion selection

Automated Data Dependent MSⁿ acquisition gives you information on not only the predicted metabolites (parent list), but also on the unpredicted metabolites. In addition, classes of metabolites can be detected using the automated Data Dependent Constant Neutral Loss (CNL) triggered MS³ feature. Data analysis can be facilitated using MetWorks™ and Mass Frontier™ software that enhances the screening and characterization of metabolites in complex matrices.

Metabolite Identification

- Analog signal-triggered Data Dependent MSⁿ acquisitions
- Constant Neutral Loss Data Dependent MSⁿ acquisitions
- MetWorks software
- Mass Frontier software

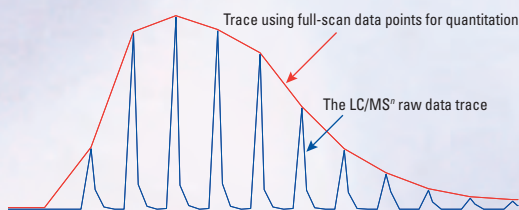

Qualitative and quantitative information in a single run

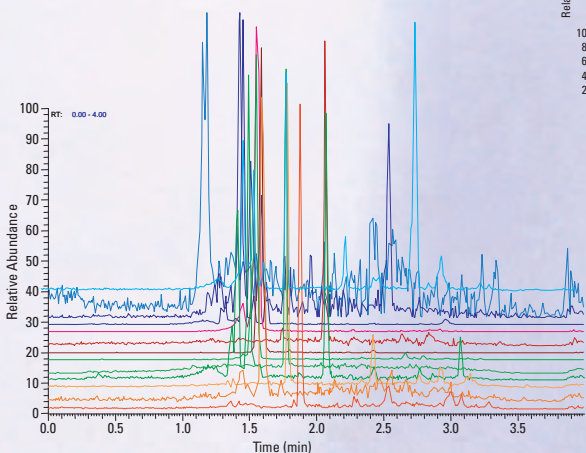

Reconstructed ion chromatograms for 13 identified drugs and metabolites in less than three minutes.

Simultaneous Metabolite Identification and Quantitation for Metabolic Stability

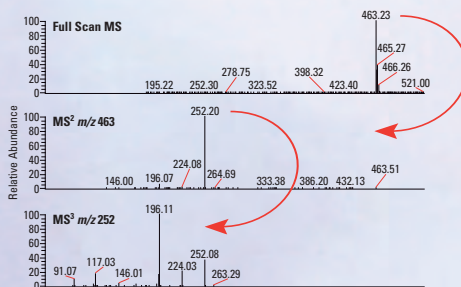

Data Dependent MSⁿ metabolite identification

		Quan and ID (LC/MS ⁿ)
Warfarin	<chem>O=C1C=CC(=C2C(=C1)C(=C(C=C2)O)C3=CC=CC=C3)C4=CC=CC=C4</chem>	98%
Bifonazole	<chem>O=C1C=CC(=C2C(=C1)C(=C(C=C2)O)C3=CC=CC=C3)C4=CC=CC=C4</chem>	83%
Ketoconazole	<chem>O=C1C=CC(=C2C(=C1)C(=C(C=C2)O)C3=CC=CC=C3)C4=CC=CC=C4</chem>	38%
Loperamide	<chem>O=C1C=CC(=C2C(=C1)C(=C(C=C2)O)C3=CC=CC=C3)C4=CC=CC=C4</chem>	17%
Nicardipine	<chem>O=C1C=CC(=C2C(=C1)C(=C(C=C2)O)C3=CC=CC=C3)C4=CC=CC=C4</chem>	1%

Quantitation for metabolic stability

ELECTRON TRANSFER DISSOCIATION (ETD) FOR PROTEOMICS AND BIOMARKER APPLICATIONS



Available for the LTQ and LTQ XL mass spectrometers, ETD offers ECD-like fragmentation in a linear ion trap, producing abundant peptide fragmentation while preserving labile

PTMs, such as phosphorylation. ETD, combined with the high ion storage capacity of Thermo Scientific linear ion traps, creates a powerful new tool for protein and peptide analysis.

ETD Makes the LTQ XL Even More Powerful for Proteomics

- Complementary with CID—Improves protein coverage
- Preserves labile PTMs, simplifying their analysis
- Automated CID and ETD in a single injection

Electron Transfer Dissociation (ETD)

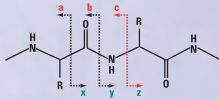
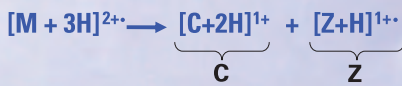

ETD ion/ion chemistry. The LTQ XL ion trap is the ideally suited device to exploit this technique.

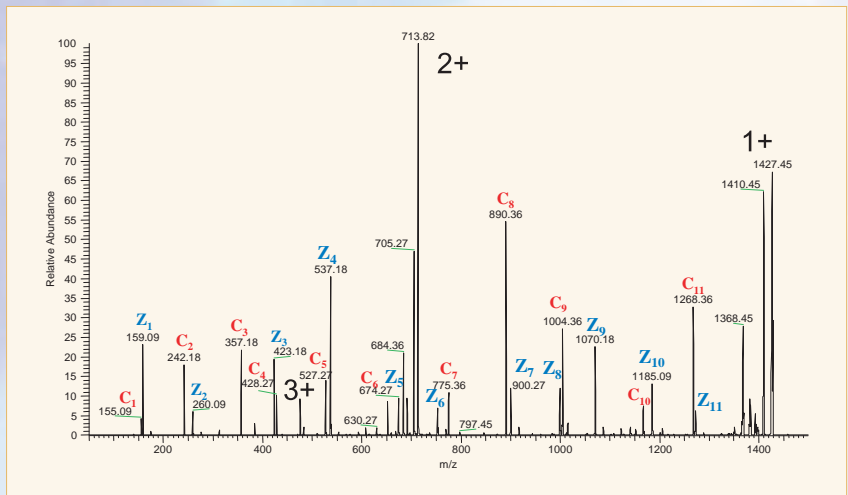

ETD MS/MS spectrum of VIP 1-12 m/z 476.3 (3+) showing rich production of c and z ion series

Detected by CID or ETD or Both

100 fmol OVALBUMIN (P01012):

MGSIGAASMEFCDFVFKELKVHHANENIFYCPIAIMSALAMVYLGAKDSTRQINKVVRFDKLPGF
GDSIEAQCGTSVNVHSSLRDILNQITKPNVDVYFSLASRLYAEERYPILPEYLQCVKELYRGGLEPINF
QTAADQARELINSWVESQTNGIIRNVLPSSVDSQTAMVLVNAIVFKGLWEKAFKDEDTQAMPFRV
TEQESKPVQMMYQIGLFRVASMASEKMKILELFPASGTMMSMLVLLPDEVSGLEQLESINFEKLTW
TSSNVMEERKIKVYLPKMKMEEKYNLTSVLMAMGITDVFSSANLSGISSAESLKISQAVHAAHAEI
NEAGREVVGSAEAGVDAASVSEEFRADHPFLFCIKHIATNAVLFFGRCSV

40 fmol ALBUMIN (P02769):

MKWVTFISLLLLFSSAYSRGVFRDRDTHKSEIAHRFKDLGEEQFKGLVLIAFSQYLQCCPFDEHVKLV
NELTEFAKTCVADESHAGCEKSLHTLFGDELCKVASLRETYGDMADCFEKQEPERNECFLSHKDDSD
PDLPLKLPDPNTLCEDEFKADEKFKWGWKLYEYIARRHPYFYAPELLYYANKYNGVFDCCQAEKDG
ACLLPKIETMREKVLASSARQLRNCASIQKFGERALKAWSVARLSQKFPKAEFVEVTKLVTDLTKV
HKECCGDLLECADRADLAKYICDNQDTISSKLEKCCDKPBLEKSHCIAEVEKDAIPENLPPLTAD
FAEDKDVCKNYQEAKDAFLGSFLYEYSRRHPEYAVSVLLRLAKEYEATLEECCAADDPHACYSTVF
DKLKHLDVDEPNLIKQNCDFEKLGEYGFQNALIVRYTRKVPQVSTPTLVEVSRSLGKVGTRCCTK
PESERMPCTEDYLSLILNRLCVLHEKTPVSEKVTCKCTESLVNRRPCFSALTPDETYVPKAFDEKLF
FHADICTLPDTEKQIKKQATLVELLKHKPKATEEQKLTVMENFVAFVDKCAADDK EACFAVEGPK
LVVSTQTALA

Comparison of Detection Methods

	CID	ETD	CID and ETD Combined	Increase in Coverage with CID and ETD Combined
Ovalbumin	137	129	184	15%
Albumin	239	248	345	18%

Improved sequence coverage with ETD; complementary to other methods

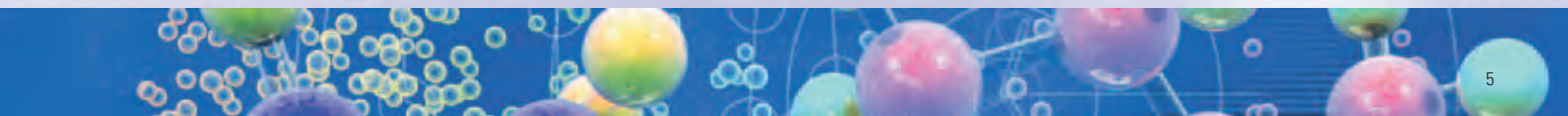

MULTIPLE IONIZATION MODES

A variety of ionization techniques are available on the LTQ XL that allow for maximum flexibility in sample analysis.

Ion Max™ source

ESI, APCI, and APPI probes are based on the revolutionary Ion Max source design. It imparts superior performance and features simple, tool-free switching of ESI and APCI probes. Full probe adjustment in the x, y, and z directions allows optimized positioning for maximum sensitivity and robustness in both low and high flow applications. The 60° angle dramatically improves performance by reducing chemical noise. Maintenance of API sources, as well as switching between various probes, is vent-free. Automatic source recognition adds to ease of use.

Nanospray source

The new Nanospray ion source features easy coupling with low dead volume and interchangeable probes for static, dynamic, and packed tip nanospray. The liquid junction provides excellent spray stability even when spraying 100% aqueous mobile phase. The versatile Nanospray source accommodates uncoated and packed tip needle designs to support low- and high-flow applications.

Source Configurations for Every Need

- Electro spray ionization (ESI)
- Atmospheric pressure chemical ionization (APCI)
- Atmospheric pressure photoionization (APPI)
- Electron transfer dissociation (ETD)
- Nanospray ionization (NSI)

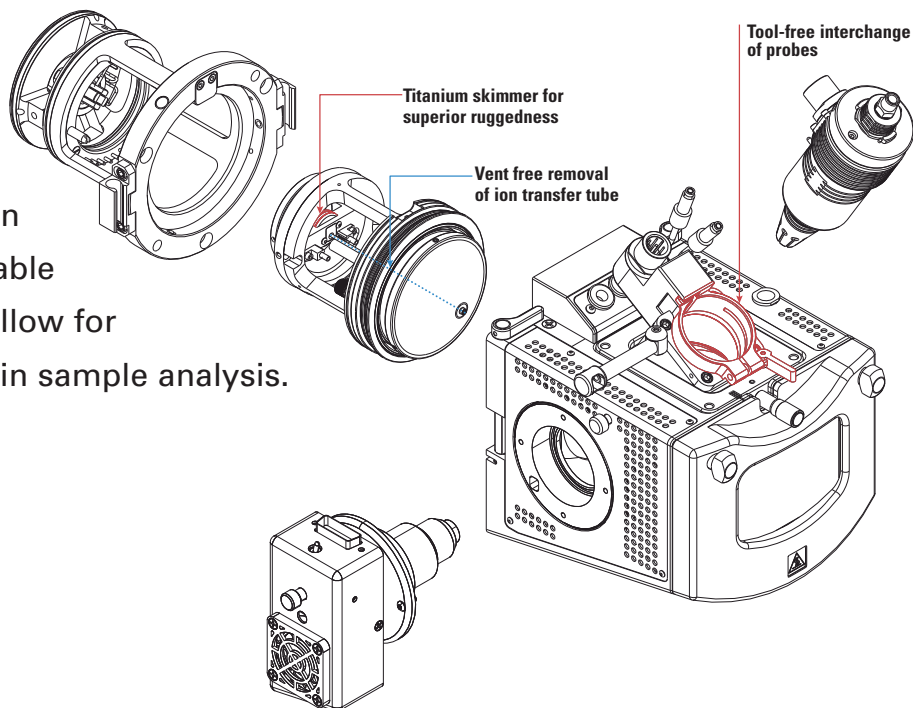

A PLATFORM FOR HIGH RESOLUTION AND HIGH MASS ACCURACY

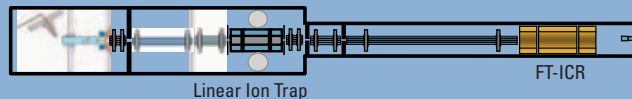

The LTQ XL hybrid mass spectrometers have established themselves as the new analytical standard for research in Proteomics and Drug Discovery.

LTQ Orbitrap™

...Breakthrough Technology

Combining patented Orbitrap technology with the LTQ XL linear ion trap, the LTQ Orbitrap offers fast, sensitive, reliable detection and identification of compounds in complex mixtures. Its outstanding mass accuracy, mass resolution and reliable, high sensitivity MSⁿ performance make it a clear alternative to existing hybrid time-of-flight systems.

LTQ FT Ultra™

...Ultimate Performance

The LTQ FT Ultra combines the most advanced Ion Trap and Fourier Transform Ion Cyclotron Resonance (FT-ICR) technologies into a single instrument, with unprecedented analytical power and versatility. Ultra-high resolution and sensitivity, coupled with sub ppm mass accuracy and accuracy, enable routine analysis of even the most complex samples. ECD and IRMPD are available for top down protein analysis.

Accurate Mass on a Chromatographic Time Scale

- Robust and reliable high mass accuracy
- Simultaneous high mass resolution, mass accuracy, and sensitivity
- Fast data acquisition rate with ultra high mass resolution

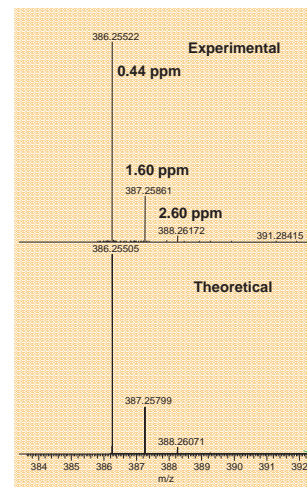
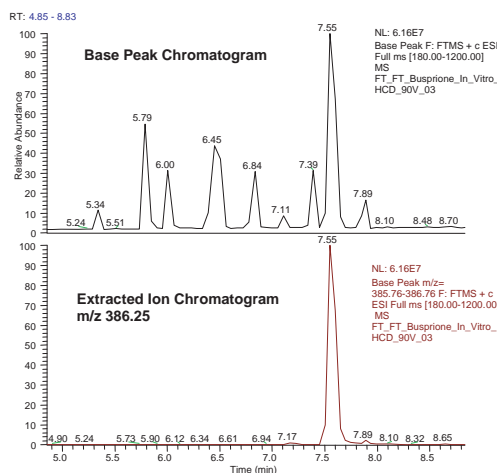

Accurate mass determination of an *in vitro* buspirone sample analyzed on the LTQ Orbitrap

Laboratory Solutions Backed by Worldwide Service and Support

Tap our expertise throughout the life of your instrument. Thermo Scientific Services extends its support throughout our worldwide network of highly trained and certified engineers who are experts in laboratory technologies and applications. Put our team of experts to work for you in a range of disciplines – from system installation, training and technical support, to complete asset management and regulatory compliance consulting. Improve your productivity and lower the cost of instrument ownership through our product support services. Maximize uptime while eliminating the uncontrollable cost of unplanned maintenance and repairs. When it's time to enhance your system, we also offer certified parts and a range of accessories and consumables suited to your application.

To learn more about our products and comprehensive service offerings, visit us at www.thermo.com.



In addition to these offices, Thermo Fisher Scientific maintains a network of representative organizations throughout the world.

Africa

+43 1 333 5034 127 • analyze.emea@thermo.com

Australia

+61 2 8844 9500 • analyze.au@thermo.com

Austria

+43 1 333 50340 • analyze.at@thermo.com

Belgium

+32 2 482 30 30 • analyze.be@thermo.com

Canada

+1 800 530 8447 • analyze.ca@thermo.com

China

+86 10 8419 3588 • analyze.cn@thermo.com

Denmark

+45 70 23 62 60 • analyze.dk@thermo.com

Europe-Other

+43 1 333 5034 127 • analyze.emea@thermo.com

France

+33 1 60 92 48 00 • analyze.fr@thermo.com

Germany

+49 6103 408 1014 • analyze.de@thermo.com

India

+91 22 6742 9434 • analyze.in@thermo.com

Italy

+39 02 950 591 • analyze.it@thermo.com

Japan

+81 45 453 9100 • analyze.jp@thermo.com

Latin America

+1 608 276 5659 • analyze.la@thermo.com

Middle East

+43 1 333 5034 127 • analyze.emea@thermo.com

Netherlands

+31 76 579 55 55 • analyze.nl@thermo.com

South Africa

+27 11 570 1840 • analyze.sa@thermo.com

Spain

+34 914 845 965 • analyze.es@thermo.com

Sweden / Norway / Finland

+46 8 556 468 00 • analyze.se@thermo.com

Switzerland

+41 61 48784 00 • analyze.ch@thermo.com

UK

+44 1442 233555 • analyze.uk@thermo.com

USA

+1 800 532 4752 • analyze.us@thermo.com

www.thermo.com

©2016 Thermo Fisher Scientific Inc. All rights reserved. Mass Frontier is a trademark of HighChem, Ltd. All other trademarks are the property of Thermo Fisher Scientific Inc. and its subsidiaries.

Specifications, terms and pricing are subject to change. Not all products are available in all countries. Please consult your local sales representative for details.

BR62208_E 08/16S

Thermo
SCIENTIFIC